Amana®

Electric Downdraft Cooktop Use and Care Manual

**Models: AKDE5E
AKDE5WW**

To the Installer: Leave this manual and other literature with the consumer for future use.

To the Consumer: Keep this manual for future reference.

Table of Contents

Important Safety Instructions _____	3
Features _____	5
Installing Modules _____	6
Operating Coil, Halogen, and Solid Disk Modules _____	8
Operating the Grill and Griddle _____	9
Operating the Fan _____	10
Cleaning the Cooktop _____	11
Tips For Using Modules _____	12
Utensil Tips _____	14
Service Information _____	15

Model Identification

Complete the registration card and promptly return card to Amana Product Registration department. If registration card is missing, call our Consumer Affairs department at 1-800-843-0304. If outside the U.S.A. call 1-319-622-5511.

When contacting Amana, provide product information. Product information is located on the appliance nameplate on the back wall of the right side module opening. Record the following information:

Model Number: _____
Serial Number: _____
P-Number: _____
Date of purchase: _____
Dealers name and address: _____

Keep a copy of sales receipt for future reference or in case warranty service is required.

Any further questions or to locate an authorized servicer, call 1-800-843-0304. If outside U.S.A. call 1-(319) 622-5511. We recommend contacting an authorized servicer if service is required.

Important Safety Instructions

As with all appliances, there are certain rules to follow for safe operation. Make sure everyone who operates this cooktop is familiar with this product's operation and with these precautions. Use this appliance only for its intended purpose as described in this manual. Pay close attention to the safety sections of manual. You can recognize the safety section by looking for the symbol or the word safety.



Recognize this symbol as a safety precaution.

⚠ WARNING

If excess grease causes a flare-up or fire when using the grill **do not put water on a grease fire.**

Follow these steps:

1. Turn the grill "OFF".
2. Cover the grill with a large metal pan or baking sheet.

Remember: Keeping the grill pan and grease pan clean will help prevent fire.

⚠ WARNING

To avoid the possibility of electrical shock, personal injury or death: **Disconnect the electrical supply to this unit before any servicing.**

⚠ CAUTION

Do not touch surface elements, element bowls, or areas near elements during or immediately after cooking. Areas near surface elements can become hot enough to cause burns. During and after use, do not touch or let clothing or other flammable material contact surface elements or areas near elements until they have sufficient time to cool.

Be sure your appliance is properly installed and grounded by a qualified technician.

Do not repair or replace any part of the appliance unless specifically recommended in the manual. All other servicing should be referred to an authorized service person.

Important Safety Instructions

1. **⚠ CAUTION** - To avoid the risk of personal injury, do not store items of interest to children in cabinets above your cooktop. Children climbing on the cooktop to reach items can be seriously injured.
2. Keep your cooktop area clear and free from combustible materials, gasoline and other flammable vapors and liquids.
3. Do not obstruct the flow of ventilation air.
4. Do not use oven cleaners. No commercial oven cleaners or protective liners should be used on the cooktop.
5. Make sure you are using the correct cooking utensils. Woks with ring stands or canners over 9" in diameter should never be used on your cooktop.
6. Select a utensil close to the size of the element. Boilovers or greasy spillovers can ignite.
7. Never leave the surface elements unattended at any heat setting. Boilovers can ignite or smoke.
8. Only certain types of glass, glass/ceramic, earthenware, or other glazed utensils are suitable for cooktop use. Some are not suitable and will break due to the sudden change in temperature.
9. Avoid pans that are unstable and tip easily. Look for easy to grip handles that will stay cool. If pan handles twist and cannot be tightened, discard the pan.
10. Utensil handles should be turned inward and not extend over adjacent surface elements. Handles that are left over adjacent elements can become hot enough to cause burns.
11. To avoid steam burns wipe up any spills with a dry cloth. Never clean or wipe a hot cooktop with a wet cloth or sponge.
12. Grease is flammable and should be handled carefully. Never leave any cooking operation unattended. Let fat cool before attempting to handle it. Do not allow grease to collect around the cooktop. Wipe up spillovers as soon as it is safe.
13. Children should not be left alone or unattended in an area where the appliance is being used. They should never be allowed to sit stand or lean on any part of the appliance.
14. Do not wear loose fitting or hanging garments while using the appliance.
15. Use only dry potholders on hot surfaces. Moist or damp potholders may result in burns from steam.
16. Do not use a towel or other bulky cloth as a potholder it may touch the element and ignite.
17. Never use the cooktop for warming or heating the room.
18. Make sure your element bowls are in place before cooking. If the bowls are not in place during cooking the wiring or components under the cooktop may be subject to damage.
19. Do not soak removable heating elements. Modules should never be placed in water.
20. If the halogen module breaks cleaning solutions and spillovers may penetrate the broken cooktop and create a risk of electrical shock. Contact an authorized service person immediately.

⚠ WARNING

Due to the nature of cooking, fires can occur as a result of overcooking or excessive grease. Though a fire is unlikely, if one occurs proceed as follows: Turn off the cooktop, if it is safe to do so. Do not turn on a vent hood. The flames could be spread. Smother the fire with a non-flammable lid, baking soda or a Class "ABC" or "BC" fire extinguisher. Do not use water on a grease fire. If smoke and fire persist call the local fire department. If there is any damage to the cooktop call a service person.

Modules

The cooktop features a choice of 5 different modules (shown).

The grill and griddle module may only be installed on the right side of the cooktop. The other modules are interchangeable and may be installed on the right or left side of the cooktop. Information on how to purchase modules can be obtained by calling your local authorized dealer.

Fan

The cooktop features a 2 speed ventilation fan located in the center of the unit.

It is not necessary to install a hood. The fan will clear odors and smoke from the kitchen.

Indicator Light

The cooktop has one indicator light. When any surface element is in operation the indicator will be illuminated.

Grill Module

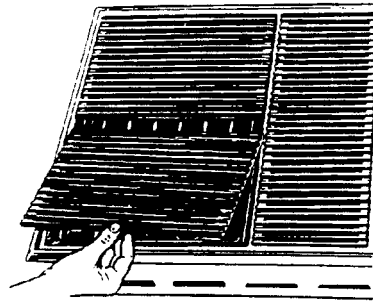

Halogen Element Module

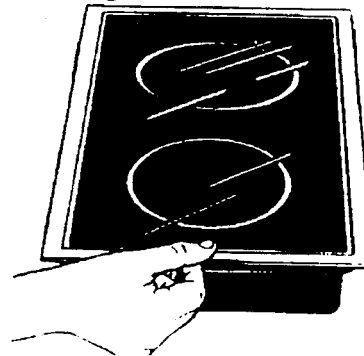

Coil Element Module

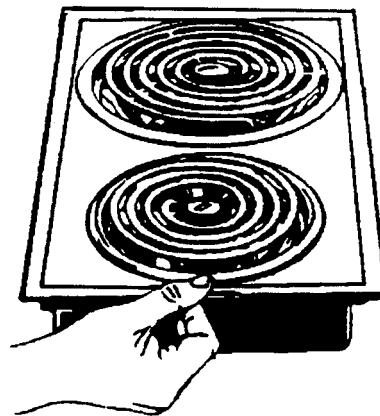

Solid Disk Element Module

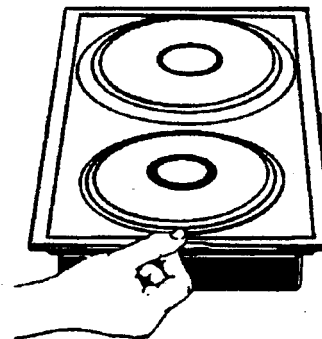

Griddle Module

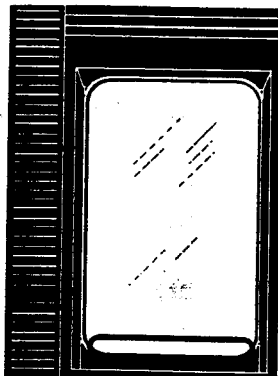

Installing Modules

Installing The Grill

1. Turn all controls to "OFF".
2. Insert the grease pan as shown.
3. Insert the grill pan as shown.
4. Insert the grill pan insert as shown.
5. Hold the grill element with the terminals pointing toward the rear of the cooktop. Slide the terminals into the plug as far as they will go.
6. Check the grill element to make sure it is fully engaged into the plug. The grill element should rest on the grill pan.
7. Place the grill grates on the grill element. The grates will rest on the ledge of the grill pan. If the grill grates are installed correctly they should not slide.

To remove the grill module turn all controls to "OFF" and reverse the steps above.

The grill may only be installed on the right side of the cooktop.

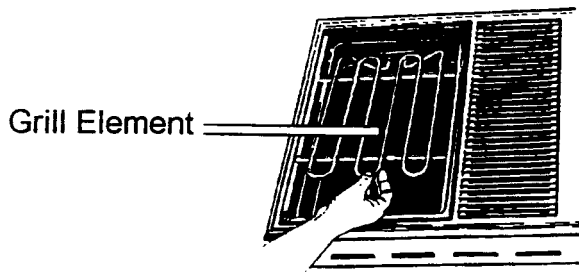
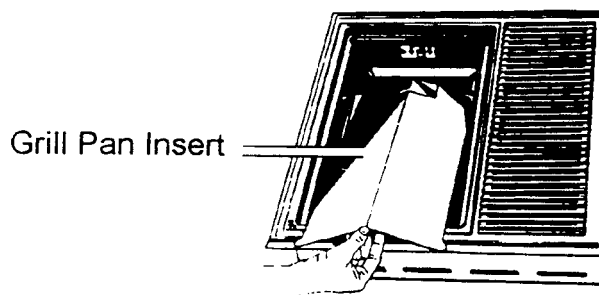
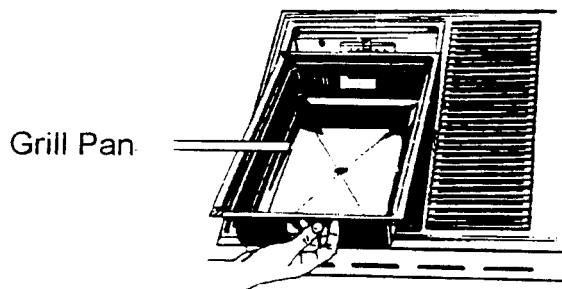
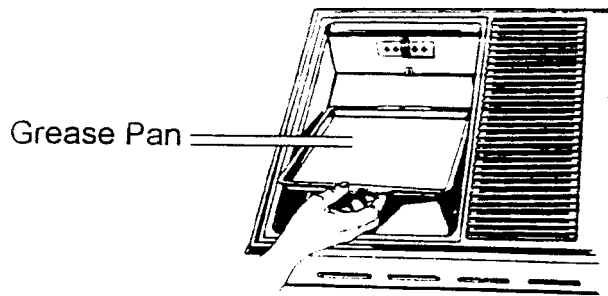

Installing The Griddle

1. Turn all controls to "OFF".
2. Insert the grease pan as shown.
3. Insert the grill pan as shown.
4. Insert the grill pan insert as shown.
5. Hold the grill element with the terminals toward the rear of the cooktop. Slide the terminals into the plug as far as they will go.
6. Check the grill element to make sure it is fully engaged into the plug. The grill element should rest on the grill pan.
7. With the grease trap toward the front of the cooktop, place the griddle pan on top of the element. The griddle pan will rest on the ledge of the grill pan.

To remove the griddle module turn all controls to "OFF" and reverse the steps above.

The griddle may only be installed on the right side of the cooktop.

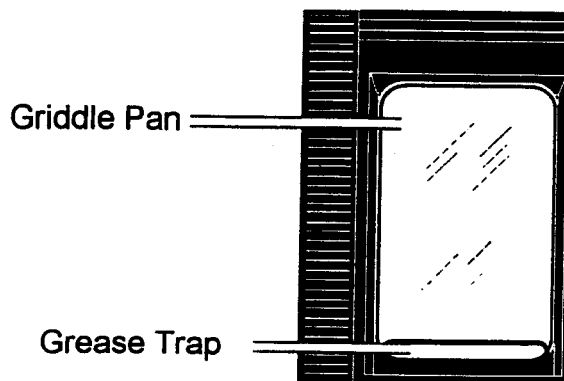

Installing the Coil, Solid Disk and Halogen Element Modules

1. Turn all controls to "OFF".
2. Hold the module with the terminals pointing toward the rear of the cooktop.
3. Slide the terminals on the module into the plug as far as they will go.
4. Check the module to make sure it is fully engaged in the terminal.

To Remove

1. Turn all controls to "OFF".
2. Using the tab on the front of the module, lift up slightly. Do not lift the module too high. Lifting the module too high can cause damage to the terminals.
3. Pull the module toward the front of the cooktop and carefully lift it out.

Operating Coil, Halogen, and Solid Disk Modules

To Operate

Push in and turn the control to the desired setting.

When Finished

Turn the control to "OFF".

Each dial can be set to any required cooking temperature. There are distinct clicks for "HI", "LO" and "OFF".

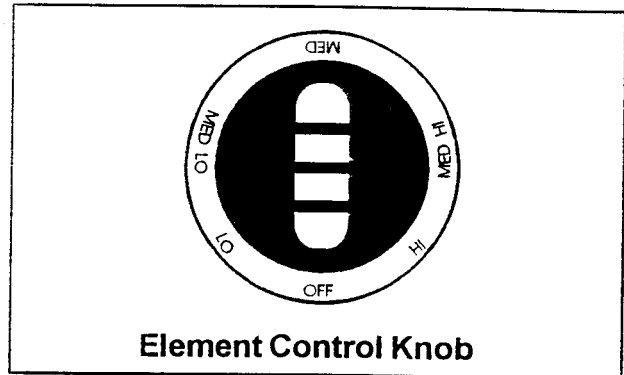

Settings

The temperature you select should be based on the amount of food and the type of utensil. The following guide can serve as a reference for temperature settings.

Cooking Guide

"LO" should be used for food that is prepared at less than boiling temperatures.

"LO" through "MED LO" can be used to maintain boiling in moderate amounts of liquid.

"MED LO" through "MED" should be used to maintain boiling of larger amounts of food, low temperature frying and to maintain correct pressure in a pressure cooker.

"MED" through "MED HI" can be used to fry meat and poultry or to maintain deep-fat frying temperatures.

"HI" should be used to bring food to boiling temperatures. When the food is boiling the temperature should be reduced to "LO", "MED LO" or "MED".

Operating The Grill and Griddle

Operating The Grill

1. Before you operate the grill for the first time lightly coat the top with cooking oil to prevent sticking.
2. Trim the excess fats from meats.
3. Push in and turn the **right front** to the desired setting. If you use the right rear control knob the indicator will light but the element will not heat, and the fan will not operate.
4. The fan will automatically come on at low speed and the indicator will light.
5. Preheat the grill for approximately 10 minutes to improve the charbroiled flavor.
6. When you are finished cooking turn the control to "OFF".
7. Clean the grill pan and grill accessories after they have cooled.

Chart For Grilling

<u>Food</u>	<u>Setting</u>	<u>Approx. Time</u>
Beef Steak		
(1/2 - 3/4")		
Rare	HI	9 min.
Medium	HI	12 min.
Well	HI	16 min.
(1 - 1-1/2")		
Rare	HI	12 min.
Medium	HI	21 min.
Well	HI	27 min.
Hamburgers	MED HI	25 min
Hot Dogs	MED HI	15 min
Pork Chops	MED HI	30 min
Ribs	MED HI	60 min
Lamb Chops	MED HI	35 min
Chicken Parts ...	MED HI	60 min
Ham Slices	MED HI	25 min.
Lobster Tails ...	HI	25 min.

Remember these times are only approximate and you must check the food for doneness.

Operating The Griddle

1. Before you operate the griddle for the first time lightly coat the top with cooking oil to prevent sticking.
2. Push in and turn the **right front** to the desired setting. If you use the right rear control knob the indicator will light but the element will not heat, and the fan will not operate.
3. The fan will automatically come on at low speed and the indicator will light.
4. When you are finished cooking turn the control to "OFF".
5. Clean the griddle pan and grill pan after they have cooled.

Operating The Fan

There is a two speed fan built into the middle of the cooktop. The fan is located beneath the vent area. This fan is necessary to remove cooking vapors, odors and smoke.

1. The fan will automatically come on at low speed when you are using the grill or griddle. The fan can be manually turned up to high speed.
2. You cannot turn the fan off while the grill or griddle are in operation.
3. The fan can be used during any cooking operation.

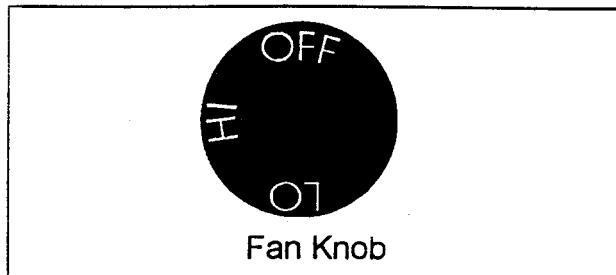

Operating

1. Turn the fan knob to the desired setting "HI" or "LO".
2. Turn the fan to "OFF" when you are finished using it.

Cleaning the Cooktop

Part	Materials to Use	General Directions
Control Knobs	Soap and Water	Pull off knobs. Wash gently but do not soak. Dry and return controls to cooktop, making sure to match flat area on the knob to the flat area on the shaft.
Outside Finish and Control Panel	Soap and Water	Wash all glass with cloth dampened in soapy water. Rinse and polish with a dry cloth. If knobs are removed, do not allow water to run down inside the surface of glass while cleaning.
Grill Cartridge and Grill Pan	Soap and Water	Wash with a nylon brush or plastic scrub pad and a dampened cloth in soapy water. Option: The grill pans and grates may also be cleaned in a dishwasher. Do not clean the grill element. Any food spilled on the element during cooking will burn off.
Halogen Cartridge	Soap and Water or ASAP	Allow the cartridge to cool before cleaning. Wash the surface with a dampened cloth and soapy water. For extra dried on soil scrub surface with ASAP cleaner available from an Amana Dealer. A single edge razor blade can be used to scrap off dried on soil. Do not use a harsh cleanser or steel wool pad. Metal markings should be cleaned after each use. If metal markings are allowed to remain on the module they will become increasingly difficult to remove.
Solid Disk Cartridge	Soap and Water or a cleaner/conditioner	Allow the cartridge to cool before cleaning. Wash the surface with a dampened cloth and soapy water. To retain the finish on the surface of the elements they should be treated with a conditioner.
Coil Element Module	Soap and Water	The coil elements do not need to be cleaned. Any food spilled on the element during cooking will burn off. Never immerse coil elements in water. The burner bowls can be removed for ease in cleaning. For extra dried on soil soak the bowls in warm soapy water. The exterior of the module can be cleaned with a dampened cloth and soapy water.
Fan Cover and Filter	Soap and Water	The fan must be off before attempting to remove the cover or filter. Wash the cover and filter in warm soapy water. For grease or dried on soil soak before cleaning. Rinse and dry thoroughly. Option: The cover and the filter may be washed in the dishwasher. Always replace the cover and filter before attempting to operate the cooktop.

Tips For Using Modules

Griddle Module

1. Before using the griddle for the first time wash it with warm soapy water. Rinse and dry thoroughly. Lightly wipe the top of the griddle surface with cooking oil to prevent the food from sticking (do not use shortening or butter). Let the cooking oil remain on the surface.
2. Do not allow the griddle pan to become full of grease. Clean after each use.
3. Always use nylon, hard rubber or wooden kitchen tools on the conventional no-stick finish.

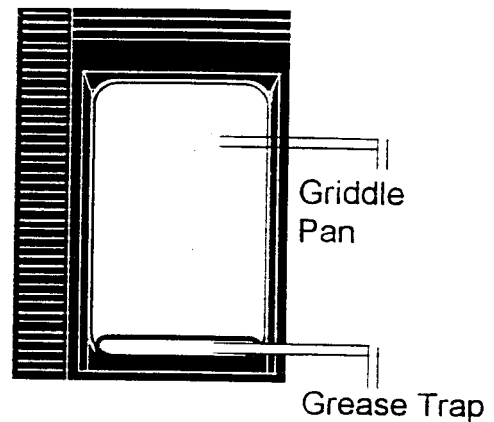

Grill Module

1. Before using the grill for the first time wash it with warm soapy water. Rinse and dry thoroughly. Lightly wipe the top of the grill surface with cooking oil to prevent the food from sticking (do not use shortening or butter). Let the cooking oil remain on the surface.
2. Do not cover the entire surface with food. This will not allow for proper air circulation.
3. Trim the excess fat from around meats to prevent smoking and flare-ups.
4. Do not pre-cook food before grilling unless it is immediately placed on the grill.
5. Check meats for doneness before removing them from the grill. Meats often brown quickly on the outside but are not done in the middle.
6. If the meat begins to cook too quickly on the outside, reduce the grill heat.

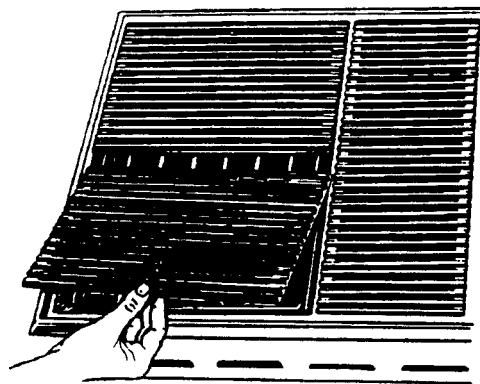

Halogen Module

1. Use heavy-gauge metal cookware not including cast iron (see right).
2. Bottom of cookware must be flat. Cookware that is warped or slightly curved on the bottom will heat slowly and sometimes may not boil water. Cookware with an aluminum disk on the bottom makes excellent contact with the cooking surface. See page 14 to test pan flatness.
3. Do not use glass, glass-ceramic, or enamel-porcelain cookware. Small imperfections on the bottom of such cookware can scratch the halogen module surface.
4. The module surface is not "scratch proof", it is highly scratch and impact resistant. With recommended cooking utensils and proper care, it will continue looking good through years of use.

⚠ CAUTION

Do not use cast iron cookware. Cast iron retains heat and may result in cooktop damage.

⚠ WARNING

To avoid the risk of serious personal injury never cook on a broken halogen module. Spillovers or cleaners can penetrate the surface of the module and create a risk of electrical shock. If the halogen module breaks notify an authorized servicer immediately.

Solid Element Module

Before using the solid element module for the first time:

Heat the element on "HI" for about five minutes to burn off the protective factory seal. Some minor smoking is normal when heating the burner for the first time.

Temperature Limiter

Each surface unit has an individual surface temperature limiter. The temperature limiter prevents the surface of the element from exceeding 880°F. The limiter will reduce the temperature if the burner has been left on for an extended period of time without a pan in place or if heat has built up as a result of improper contact with the pan. The solid disk elements hold heat longer than coil elements. Therefore, the heat can be turned off earlier in the cooking process and food will continue to cook using the residual heat.

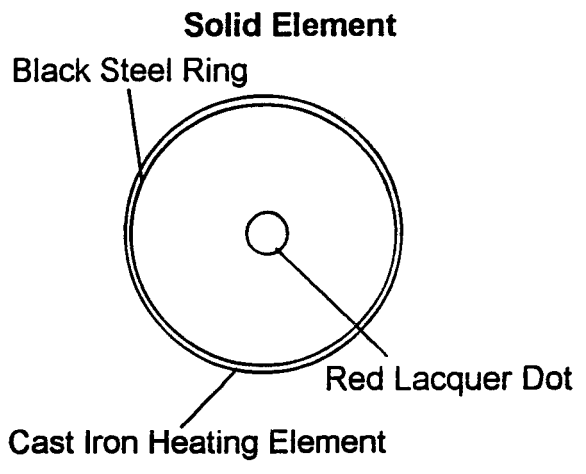

Note: The red lacquer dot in the middle of the burner will eventually wear away. This will not affect the performance of the burner.

Utensil Tips

Cooking Utensil Chart

Type	Response To Temperature Changes	Recommended Usage
Aluminum	Heats and Cools Quickly	Frying, Braising, Roasting
Cast Iron	Heats and Cools Slowly	Low Heat Cooking, Frying
Copper, Tin Lined	Heats and Cools Quickly	Gourmet Cooking, Wine Sauces, Egg Dishes
Enamelware	Response Depends on Base Metal	Low Heat Cooking
Glass Ceramic	Heats and Cools Slowly	Low Heat Cooking
Stainless Steel	Heats and Cools at Moderate Rate	Soups, Sauces, Vegetables, General Cooking

Check the bottom of your pans to ensure they are flat.

1. Place a ruler along the bottom of the pan.
2. Rotate the straight edge 360° around the bottom of the pan.
3. If you see light or a gap between the ruler and the pan bottom, the pan will not cook efficiently.

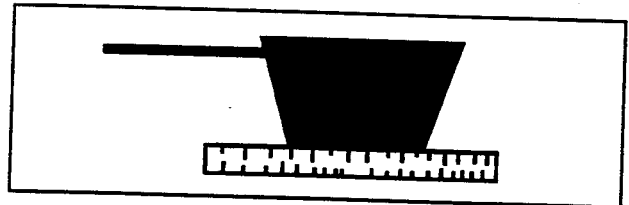

Before Calling For Service

Avoid unnecessary service calls for difficulties that are not a result of defective workmanship or materials. If the problem is not caused by workmanship or materials, or if the component is customer replaceable, you will be charged for a service person's travel expenses and labor, even though the product may be under warranty.

When Service Is Required

The dealer can give you the name of your nearest Authorized Service Center. Help them give you prompt service by giving them:

1. An accurate description of the trouble.
2. Complete model, serial, and P-number located on the back wall of the right side module opening. They can be seen by removing the right module.
3. Proof of purchase (sales receipt on request)

Keep an accurate record of any service calls.

If you have a service problem that is not resolved please

**Write: Consumer Affairs Department
Amana Refrigeration, Inc.
Amana, Iowa 52204**

To locate an authorized servicer or if you have questions concerning product usage, installation, or warranty, call:

**Consumer Information Line
Toll Free 1-800-843-0304
Outside the U.S.A. (319) 662-5511**